



MAX5954L Evaluation Kit/Evaluation System

General Description

The MAX5954L evaluation kit (EV kit) is a fully assembled and tested surface-mount single hot-plug controller PC board for a single PCI Express™ hot-plug slot. The circuit uses a MAX5954L IC in a 36-pin thin QFN package. The EV kit provides independent power control for the 12V, 3.3V, and 3.3V-auxiliary outputs of a single PCI-Express x16 connector. The EV kit demonstrates the MAX5954L IC's inrush current control, output overcurrent/short-circuit protection and input undervoltage monitoring features.

The MAX5954L IC controls two separate external n-channel MOSFETs for the 12V and 3.3V outputs, respectively. Additionally, the MAX5954L has an internal MOSFET that controls the 3.3V-auxiliary output. Switches are provided to independently enable/disable the 12V/3.3V main and 3.3V-auxiliary supplies.

The MAX5954L EV kit can be reconfigured for evaluating a x1, x4, or x8 PCI Express single hot-plug design. Alternatively, the EV kit can also be used to demonstrate the MAX5954L hot-plug features without using the PCI Express x16 connector.

The EV kit includes a MAX7313 I/O expander that enables communication through an SMBus™ interface for the MAX5954L signals and some of the PCI Express signals. A CMAXQUSB interface board can be used to enable PC communication through the SMBus interface. Windows® 98-/2000-/XP-compatible GUI software is provided to access the MAX7313 I/O expander and MAX5954L signals. The MAX5954L EV kit can also be used in local control, without any software, or interfaced to a user-provided SMBus system signal.

Order the MAX5954LEVCMAXQUSB for a complete PC-based evaluation of the MAX5954L. Order the MAX5954LEVKIT if you already have a CMAXQUSB interface board or do not require PC-based evaluation of the MAX5954L.

Ordering Information

PART*	IC PACKAGE	SMBus INTERFACE TYPE
MAX5954LEVKIT	36 TQFN-EP**	Not included
MAX5954LEVCMAXQUSB	36 TQFN-EP**	CMAXQUSB

*Temp range is 0°C to +70°C for all parts.

**EP = Exposed paddle.

Note: The MAX5954L EV kit software is provided with the MAX5954LEVKIT. However, the CMAXQUSB interface board is required to interface the EV kit to a computer when using the software.

Features

- ◆ Demonstrate PCI Express x16 Single Hot-Plug Design
- ◆ Independent Output Controls
 - 12V and Up to 5.5A (Adjustable)
 - 3.3V and Up to 3A (Adjustable)
 - 3.3V-Aux and Up to 0.375A
- ◆ Evaluate Hot-Plugging PCI Express x1, x4, x8, or x16 Line Cards
- ◆ Demonstrate Input Inrush Current Control
- ◆ Demonstrate Output Overcurrent/Short-Circuit Protection
- ◆ Monitor Input Undervoltage for 12V, 3.3V, and 3.3V-Aux with Status Reports
- ◆ Configurable Power-On Reset (POR)
- ◆ Independent On/Off Controls for 12V/3.3V
- ◆ Independent 3.3V-Aux Output with Separate On/Off Control
- ◆ Latched Output After Fault Conditions (12V, 3.3V, 3.3V-Aux)
- ◆ Input/Output Interface Using a MAX7313 I/O Expander (SMBus Interface) or Local Control
- ◆ Can be Controlled Locally without Software
- ◆ Windows 98-/2000-/XP-Compatible Software
- ◆ Surface-Mount Components
- ◆ Fully Assembled and Tested

PCI Express is a trademark of PCI-SIG Corp.

SMBus is a trademark of Intel Corp.

Windows is a registered trademark of Microsoft Corp.

Evaluate: MAX5954L/MAX5954A

MAX5954LEVCMAXQUSB (MAX5954L EV System)

Component List

PART	QTY	DESCRIPTION
MAX5954LEVKIT	1	MAX5954L evaluation kit
CMAXQUSB	1	SMBus interface board



MAX5954L Evaluation Kit/Evaluation System

Evaluate: MAX5954L/MAX5954A

MAX5954LEVKIT Component List

DESIGNATION	QTY	DESCRIPTION
C1	1	1500 μ F, 16V electrolytic capacitor (12.5mm x 13.5mm case) Panasonic EEFVK1C152Q
C2	1	3300 μ F, 6.3V, low-impedance electrolytic capacitor (12.5mm x 13.5mm case) Sanyo 6.3CV3300KX
C3, C4, C5	3	10 μ F \pm 20%, 25V X7R ceramic capacitors (1812) TDK 4532X7R1E106M
C6–C9	4	1 μ F \pm 10%, 16V X7R ceramic capacitors (0805) Murata GRM21BR71C105K
C11, C12	2	0.1 μ F \pm 10%, 16V X7R ceramic capacitors (0603) Murata GRM188R71C104K
C13, C14	0	Not installed ceramic capacitors (0805)
D1	1	1A, 40V Schottky diode (SOD-123) Diodes Incorporated 1N5819HW-F
D2, D3, D5, D6	4	Green surface-mount LEDs (1206)
D4	1	Yellow surface-mount LED (1206)
J1	1	PCI Express x16 connector Molex 87715-3305
J2	1	9-pin header
J4	1	2 x 10 right-angle female receptacle
JU1, JU2	2	2-pin headers
JU3, JU4	2	3-pin headers
N1, N2	2	20V, 13.4A n-channel MOSFETs (SO-8) Vishay Si7448DP-T1
R1	1	0.008 Ω \pm 2%, 0.5W sense resistor (2010) IRC LRC-LRF2010-01-R008-G or Vishay WSL20108L000F

DESIGNATION	QTY	DESCRIPTION
R2	1	750 Ω \pm 1% resistor (1210)
R3	1	1k Ω \pm 5% resistor (1206)
R4, R10, R11, R12, R17, R20, R21, R22	0	Not installed resistors (0805)
R5, R8, R18, R19, R23, R24, R25	7	10k Ω \pm 5% resistors (0603)
R6, R7	2	51k Ω \pm 5% resistors (0603)
R9	1	3.3k Ω \pm 5% resistor (0603)
R13, R14, R16, R28	4	150 Ω \pm 5% resistors (0603)
R15	1	0.005 Ω \pm 1%, 0.5W sense resistor (2010) Vishay WSL20105L000FTA
SW1	1	SPST momentary-contact switch
SW2, SW3	2	SPDT slide switches
VIN1, VIN2, VIN3, GND, GND	5	Uninsulated banana jacks
TP1, TP2, TP3, TP13, TP15, TP16, TP18, TP19, TP20	9	PC test points, red
TP4–TP12	9	PC test points, black
TP14, TP17	2	PC test points, miniature, red
U1	1	MAX5954LETX (6mm x 6mm, 36-pin TQFN)
U2	1	16-port I/O expander (4mm x 4mm, 24-pin TQFN) MAX7313ATG
—	4	Shunts (JU1–JU4)
—	1	MAX5954L EV kit PC board
—	2	Rubber bumpers

MAX5954L Evaluation Kit/Evaluation System

Component Suppliers

SUPPLIER	PHONE	WEBSITE
Diodes Incorporated	805-446-4800	www.diodes.com
IRC	361-992-7900	www.ircct.com
Murata	770-436-1300	www.murata.com
Panasonic	714-373-7366	www.panasonic.com
Sanyo Electronic Device	619-661-6835	www.sanyodevice.com
TDK	847-803-6100	www.component.tdk.com
Vishay	—	www.vishay.com

Note: Indicate that you are using the MAX5954L when contacting these component suppliers.

Quick Start

Required equipment

- One each of the following DC power supplies
 - 12V, 7A
 - 3.3V, 5A

- Three voltmeters

The 3.3V power supply can be used to power the main 3.3V and 3.3VAUX inputs.

The MAX5954L EV kit is fully assembled and tested. Follow these steps to verify board operation. **Do not turn on the power supply until all connections are completed.**

Note: The banana leads connecting the 12V and 3.3V power supply to the EV kit must be short (< 12in long).

MAX5954L Hardware-Only Configuration

- 1) Verify that a shunt is installed on jumper JU1 (PRES-DET).
- 2) Verify that a shunt is not installed on jumper JU2 (MRL).
- 3) Verify that shunts are installed on pins 1 and 2 of jumpers JU3 and JU4 (local switch control).
- 4) **Utilizing short 10A-rated banana leads (< 12in long)**, connect the 12V DC power supply to the VIN1 banana jack. **Utilizing short 10A-rated banana leads (< 12in long)**, connect the supply ground to the GND banana jack.

- 5) **Utilizing short 10A-rated banana leads (< 12in long)**, connect the 3.3V DC power supply to the VIN2 banana jack. **Utilizing short 10A-rated banana leads (< 12in long)**, connect the supply ground to the GND banana jack.
- 6) Connect the 3.3V DC power supply to the VIN3 banana jack with a short banana lead.
- 7) Connect a voltmeter to the 12V pad or test point TP13 and GND. Connect a voltmeter to the 3.3V pad or test point TP16 and GND. Connect a voltmeter to the 3.3VAUX pad or test point TP19 and GND.
- 8) Set switches SW3 (ON) and SW2 (AUXON) to the OFF position.
- 9) Turn on both power supplies in any sequence.
- 10) Set switches SW3 (ON) and SW2 (AUXON) to the ON position.
- 11) Verify that the voltage at the following pads is as shown below:
 - 12V = 12V
 - 3.3V = 3.3V
 - 3.3VAUX = 3.3V
- 12) Sliding switches SW3 and SW2 to the OFF position disables the respective output on the MAX5954L EV kit single hot-plug controller main or auxiliary outputs.
- 13) Test points TP14, TP17, and GND pads nearby are provided to observe MOSFETs N1 or N2 gate voltage, respectively, with an oscilloscope.

Software and Hardware Quick Start

The MAX5954L EV kit is fully assembled and tested. Follow these steps to verify board operation. **Do not turn on the power supplies until all connections are completed.**

Required Equipment:

- One each of the following DC power supplies
 - 12V, 7A
 - 3.3V, 5A (used to power the main 3.3V and 3.3VAUX inputs)
- MAX5954L EV kit and CMAXQUSB interface board
- Windows 98/2000/XP computer with a spare USB port
- USB I/O extension cable, straight-through, male-to-female cable
- Three voltmeters for confirming output voltages

MAX5954L Evaluation Kit/Evaluation System

MAX5954L Software and Hardware Configuration

- 1) Verify that a shunt is not installed on jumper JU1 (PRES-DET) and a shunt is installed on jumper JU2 (MRL).
- 2) Verify that shunts are installed on pins 2 and 3 of jumpers JU3 and JU4 (computer control) on the EV kit.
- 3) **Utilizing short 10A-rated banana leads (< 12in long)**, connect the 12V DC power supply to the VIN1 banana jack. **Utilizing short 10A-rated banana leads (< 12in long)**, connect the supply ground to the GND banana jack.
- 4) **Utilizing short 10A-rated banana leads (< 12in long)**, connect the 3.3V DC power supply to the VIN2 banana jack. **Utilizing short 10A-rated banana leads (< 12in long)**, connect the supply ground to the GND banana jack.
- 5) Connect the 3.3V DC power supply to the VIN3 banana jack with a short banana lead.
- 6) Connect a voltmeter to the 12V pad or test point TP13 and GND. Connect a voltmeter to the 3.3V pad or test point TP16 and GND. Connect a voltmeter to the 3.3VAUX pad or test point TP19 and GND.
- 7) Connect the CMAXQUSB interface board to the MAX5954L EV kit's J4 connector.
- 8) Set both CMAXQUSB interface board SW1 switches to enable. These provide pullup resistors for the SDA and SCL 2-wire bus signals.
- 9) Install the MAX5954L evaluation software on your computer by running the INSTALL.EXE program on the CD-ROM disk. The program files are copied and icons are created for them in the Windows Start Menu. Restart the computer when prompted. For Windows 2000 and XP, you may need administrator privileges.
- 10) Turn on the 12V and 3.3V power supplies for the EV kit. The CMAXQUSB interface board is powered through the computer's USB port.
- 11) Connect the included USB cable from the PC to the CMAXQUSB interface board. A **Building Driver Database** window should pop up in addition to a **New Hardware Found** message. If you do not see any window that is similar to the one described above after 30s, try removing the USB cable from the CMAXQUSB interface board and reconnect it again. Administrator privileges are required to install the USB device driver on Windows 2000 and XP.

- 12) Follow the directions of the **Add New Hardware Wizard** to install the USB device driver. Choose the **Search for the best driver for your device** option. Specify the location of the device driver as **C:\Program Files\MAX5954L** using the **Browse** button. Refer to the document *Troubleshooting USB.PDF* included with the software for more information.
- 13) Start the MAX5954L program by opening its icon in the Start Menu.
- 14) Install the shunt on jumper JU1 (PRES-DET) or insert a PCI Express card into connector J1.
- 15) The software detects the CMAXQUSB interface board, the SMBus address of U2, and updates the status screen. The software is then ready for changes in the command section.

See the *MAX7313 Input/Output Expander and SMBus Interface* section for configuring the input/output expander, using the CMAXQUSB interface board. See the *Detailed Description of Software* in this document for more information on the software GUI features.

Detailed Description of Hardware

The MAX5954L EV kit demonstrates a PCI Express x16 single hot-plug circuit design. A PCI Express x16 single channel is provided to evaluate a PCI Express x16 line card. The EV kit uses a latching MAX5954L hot-plug controller in a 36-pin TQFN package to control the output power and monitor for faults.

The MAX5954L IC controls output power independently and external n-channel MOSFETs are used to control power to the 12V and 3.3V outputs. Current-sensing resistors (R1, R15) are used for monitoring current at the 12V and 3.3V outputs. An internal MOSFET on the MAX5954L controls the 3.3V-auxiliary output.

If an overcurrent fault persists, the MAX5954L shuts down the channel. The fault is reported at the open-drain power-good pin (PWRGD) and fault pin (FAULT). The MAX5954L power-on reset (POR) is configured for a default value of 160ms; however, the POR can be reconfigured by installing resistor R11.

Slide switches are provided to enable/disable the main output (SW3) and auxiliary (SW2) 3.3V output independently when the SMBus control is not used. Jumper JU1 can be used to provide a presence-detect function if a PCI Express card is not used. Momentary pushbutton switch SW1 is provided to demonstrate the MAX5954L debounced logic gate input and output signals.

MAX5954L Evaluation Kit/Evaluation System

The MAX5954L EV kit features green LEDs connected to the 12V, 3.3V, and 3.3V-auxiliary outputs that indicate if the respective output is currently powered. Red test points for the 12V and 3.3V outputs, various PCI Express signals, and other circuit signals (such as the gate drive of each MOSFET) have been provided for probing on the EV kit board. All of the EV kit's black test points are GND points.

The EV kit also features PC board pads for installing external resistors and capacitors near each MOSFET gate terminal to slow the MOSFETs gate-turn-on time. Surface-mount 0805 case size components can be installed at these locations. See Figure 3 for each of the MOSFETs' gate reference designators.

When adding capacitance to the gates of N1 and N2, ensure that adequate startup time (t_{SU}) is allowed. To successfully power up, the $5\mu A$ gate-charge current must be able to bring the gate voltages of N1 and N2 above their maximum \overline{PWRGD} thresholds before t_{SU} has elapsed. The maximum \overline{PWRGD} threshold for 12V MOSFET N1 is 4.8V above V_{12VIN} , and the threshold for 3.3V MOSFET N2 is 4.5V above $V_{3.3VIN}$. The time required to reach these thresholds is

$$\frac{\text{total gate capacitance} \times \overline{PWRGD} \text{ threshold voltage}}{5\mu A}$$

The EV kit can be reconfigured for evaluating a x1, x4, or x8 PCI Express single hot-plug design by replacing current-sense resistor R1. Consult the appropriate PCI Express specification or Table 1 in the MAX5954L IC data sheet for selecting other designs. PC board pads are provided to demonstrate the MAX5954L hot-plug features without using the PCI Express x16 connector.

For evaluating external DC loads, the cables connecting the 12V and 3.3V outputs to the external DC load must be rated for at least 10A and be shorter than 12in. Additionally, current-sense resistors R1 and R15 are configured for the maximum allowable output current on the 12V and 3.3V outputs. These resistors should be reconfigured only for lower output currents.

The MAX5954L EV kit features a MAX7313 16-port I/O expander (U2) and PC board pads for interfacing to a user's SMBus system. Resistors R20–R25 configure the MAX7313 SMBus serial address. The MAX7313 can be used to enable/disable the EV kit's main outputs and auxiliary 3.3V output independently. See the MAX7313 *Input/Output Expander and SMBus Interface* section for more details.

Jumper and Switch Selection

Several jumper and switch selections in the following tables display the functions provided by the MAX5954L EV kit.

Table 1. Channel Presence-Detect Functions

JUMPER	SHUNT	MAX5954L PIN CONNECTION	EV KIT OPERATION SIMULATED
JU1	Installed	$\overline{PRES-DET}$ pin pulled low	PCI Express card inserted in channel
JU1	None*	$\overline{PRES-DET}$ pin pulled high	No PCI Express card in channel

*When using a real PCI Express card, this jumper's shunt must be removed so that the card has control of the presence detection.

Presence Detect

The MAX5954L EV kit features a jumper that can simulate a PCI Express x16 card being plugged into connector J1. Jumper JU1 is used to provide a presence-detect function for the channel. An external load (resistive and capacitive) must be connected to the channel's output PC board pads to simulate a real PCI Express card. Table 1 lists the various jumper options.

Channel Enable/Disable Switches

The MAX5954L EV kit features two switches to enable/disable the 12V/3.3V main and 3.3V-auxiliary outputs. The switches can also be used to reset the channel when it has latched off after a fault has occurred. Table 2 lists the various switch options.

Table 2. Channel Switch Functions

SWITCH	SWITCH STATE	MAX5954L PIN CONNECTION	MAX5954L OPERATION
SW3	On	ON pin pulled high	Enable main outputs
SW3	Off	ON pin pulled low	Disable main outputs
SW2	On	AUXON pin pulled high	Enable 3.3V-auxiliary output
SW2	Off	AUXON pin pulled low	Disable 3.3V-auxiliary output

*When using a real PCI Express card, this jumper's shunt must be removed so that the card has control of the presence detection.

MAX5954L Evaluation Kit/Evaluation System

Control Methods, Other Configurations, and I/O Expander

Fault Resetting

The MAX5954L EV kit features two slide switches to reset a latched fault at the channel. The respective switch resets the MAX5954L and unlatches faults when toggled from on to off. See Table 2 for resetting the channel. Refer to the MAX5954L data sheet for additional functions of the MAX5954L ON pin.

Fault Timeout and POR Periods

The MAX5954L fault timeout period is configured for a default value of 10ms and can be reconfigured to a new timeout period by installing surface-mount resistor R10. The MAX5954L POR timeout period is configured for a default value of 160ms, however a new POR timeout period can be reconfigured by installing surface-mount resistor R11. Refer to the MAX5954L data sheet *Applications Information* section for selecting the values of resistors R10 or R11.

When adjusting the t_{FAULT} timeout, be sure to allow adequate startup time, t_{SU} . The minimum required startup time for a given output is the greater of either

$$\frac{\overline{PWRGD} \text{ threshold voltage} + \text{input voltage} \times \text{output load capacitance}}{5\mu\text{A}}$$

or

$$\frac{\text{total gate capacitance} \times \overline{PWRGD} \text{ threshold voltage}}{5\mu\text{A}}$$

as described in the *Detailed Description of Hardware* section. Refer to the MAX5954 data sheet for more information on selecting R_{TIM} and R_{PORADJ} .

Forced On Inputs

The PCI Express slot can be forced to turn on regardless of the MAX5954L logic status inputs. To force the channel on, install surface-mount resistor R12. A typical value is less than 1k Ω .

Current Limiting

The MAX5954L EV kit can evaluate other current-limit configurations for the 12V and 3.3V main outputs. Resistor R1 sets the 12V current limit and R15 sets the 3.3V current limit. The 3.3V-auxiliary current limit is fixed at 470mA (typ) and is not reconfigurable. Refer to the MAX5954L IC data sheet for information on selecting other current-limit resistors.

Evaluating Other MAX5954L Hot-Plug Controllers

The MAX5954L EV kit can be used to evaluate the MAX5954A. Replace U1 with the MAX5954A that can be ordered by contacting the factory.

MAX7313 Input/Output Expander and SMBus Interface

The MAX5954L EV kit features a MAX7313 I/O expander (U2) and PC board pads for connecting to an SMBus system (SDA and SCL signals). The I/O expander interfaces with the PRES-DET, FAULT, ON, and OUT signals of the MAX5954L. A 9-pin header, J2, is provided to enable easy access to each signal through a ribbon cable or scope probe. Green and yellow LEDs (D3, D4) are also provided for user applications such as status indication. Jumper JU2 (MRL) is provided to mimic a PCI Express mechanical retention locking (MRL) signal. Surface-mount resistors R20–R25 configure the MAX7313 SMBus address, which is set to 0x40 by default.

Table 3. MAX5954L Channel ON Signals Configuration

JUMPER	SHUNT LOCATION	MAX5954L PIN CONNECTION	EV KIT OPERATION
JU4	1 and 2	ON controlled by SW3	Local switch control
JU3	1 and 2	AUXON controlled by SW4	Local switch control
JU4	2 and 3	ON controlled by U2, MAX7313 with SMBus	SMBus or computer control
JU3	2 and 3	AUXON controlled by U2, MAX7313 with SMBus	SMBus or computer control

If the MAX7313 I/O expander is used to control the MAX5954L ON/AUXON signals and read back the various other signals, jumpers JU3 and JU4 must be reconfigured or U2 may be destroyed when switching logic states. See Table 3 below for configuring jumpers JU3 and JU4. Pads are provided on the EV kit's PC board for interfacing with a user's system SMBus VDD, SDA, SCL, and GND signals if the CMAXQUSB interface board is not used.

If a user's SMBus system is not available, a Windows-based computer can be interfaced with the EV kit by connecting the CMAXQUSB interface board to connector J4. The CMAXQUSB interface board enables the computer to interface with the EV kit's SMBus signals. The interface board and GUI software provides the user with the capability of controlling and monitoring the MAX5954L IC using the MAX7313 I/O expander.

MAX5954L Evaluation Kit/Evaluation System

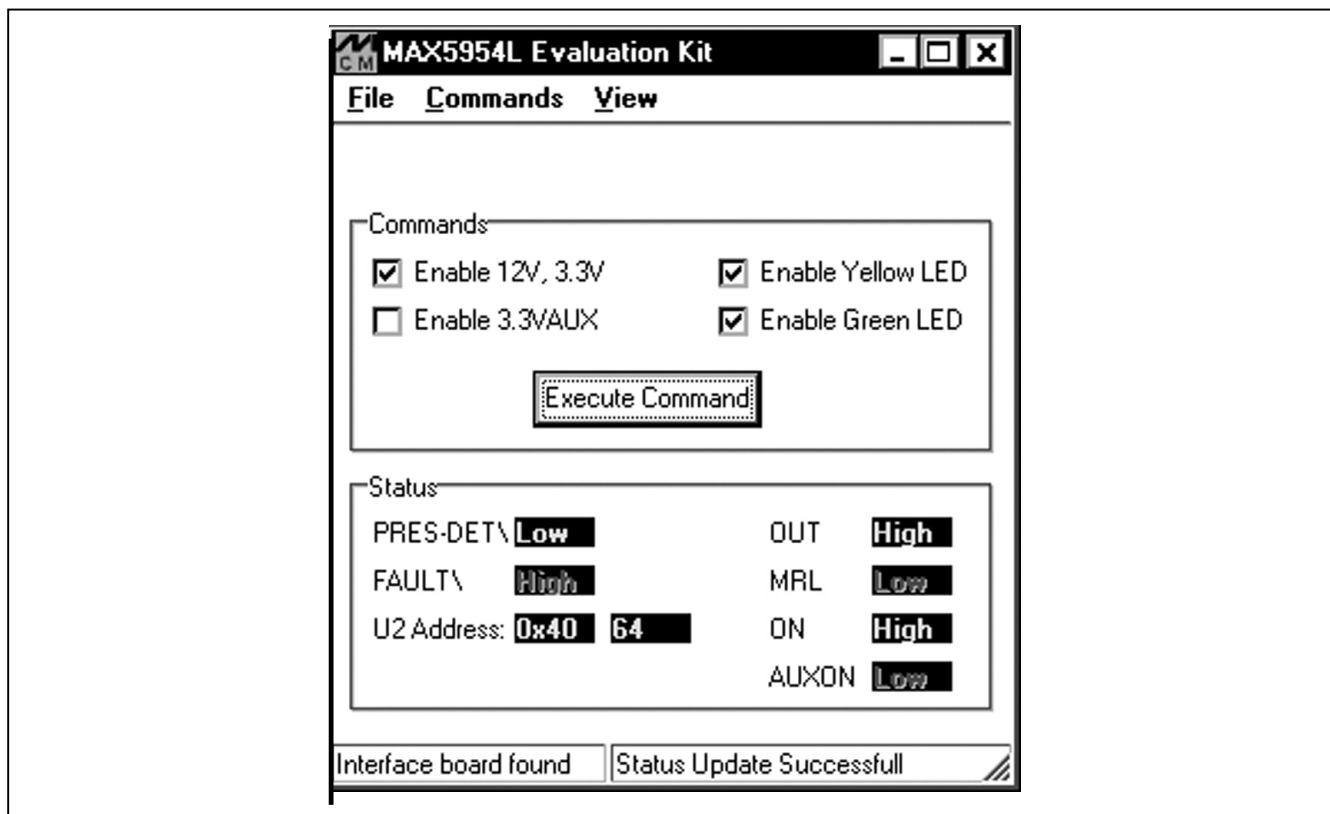

Figure 1. MAX5954L Evaluation Software Main Window for Reading Current EV Kit Status and Sending Commands

Table 4. MAX7313 I/O Port Configuration/Function

MAX7313 PORT I/O	PORT P7 (BIT D7)	PORT P6 (BIT D6)	PORT P5 (BIT D5)	PORT P4 (BIT D4)	PORT P3 (BIT D3)	PORT P2 (BIT D2)	PORT P1 (BIT D1)	PORT P0 (BIT D0)
Port Config	OUTPUT	OUTPUT	INPUT	INPUT	OUTPUT	OUTPUT	INPUT	INPUT
EV Kit Function	YELLOW LED (D4)	GREEN LED (D3)	PRES-DET	FAULT	AUXON	ON	OUT	MRL

Detailed Description of Software

Words in boldface are user-selectable features in the MAX5954L EV kit software. A mouse or the keyboard's tab key is used to navigate various items on the Main Window. Most of the main window's available functions and a few more can be evaluated by using the **pulldown menu**. The software features a demo mode that is available using the **View/Demo Mode pulldown menu**.

Software Startup

Upon starting the program, the MAX5954L EV kit software automatically detects U2 address and configures

its I/O. See Table 4 for U2's configuration by the software. The MAX5954L EV kit's various status signals are then updated by the program approximately every 500ms. Use the checkboxes to enable/disable various EV kit functions and then select the **Execute Command** button to send the commands to U2 and/or U1. Deselecting a checkbox disables the command.

The software's Status area provides information on the various MAX5954L and PCI Express system signals condition. The MAX7313 U2 SMBus address is provided in hexadecimal and decimal format, respectively. The left bottom status bar of the main window provides the CMAXQUSB interface board communication status. The right bottom status bar provides the current pro-

MAX5954L Evaluation Kit/Evaluation System

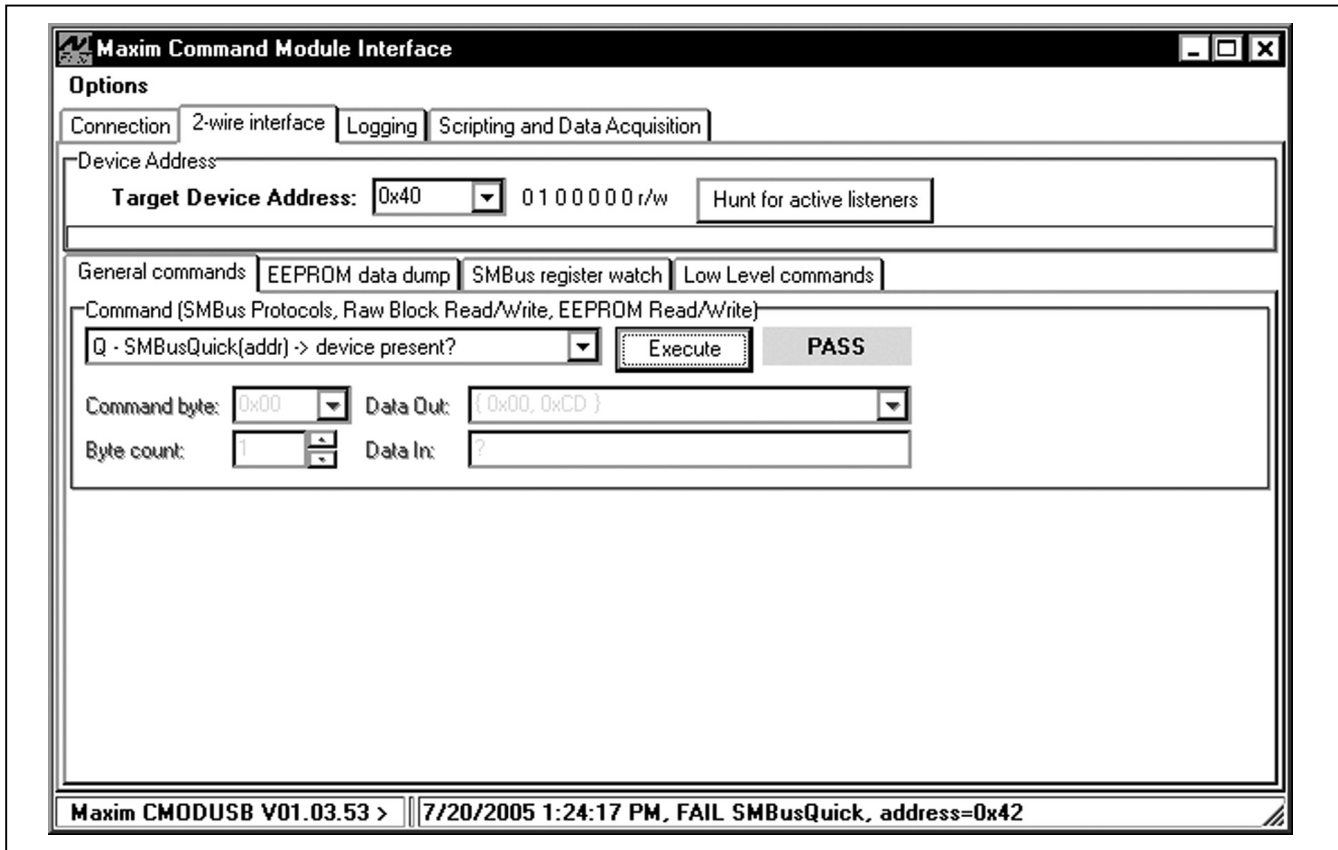

Figure 2. 2-Wire Interface Window (Provides Direct, Low-Level Access to the MAX5954L with the MAX7313 and SMBus 2-Wire Interface)

gram status and SMBus communication status with respect to U2.

The MAX5954L EV kit software configures the CMAXQUSB interface board's SMBus communication speed to 400kHz by default. The speed can be reduced to 100kHz if required, by selecting the pull-down menu's **View|2-Wire Speed|100kHz** selection. This may be required if slower SMBus or 2-wire devices are connected to the bus on the EV kit.

General-Purpose 2-Wire Interface Utility

The general-purpose 2-wire interface utility can also be used to communicate with the MAX7313 and control or read back signals from the MAX7313 and/or MAX5954L. Use the **View|Interface** pulldown menu to access the utility. The utility configures the SMBus interface parameters such as start and stop bits, acknowledgements, and clock timing. The 2-wire interface screen allows the user to send general-purpose SMBus commands using the **SMBusWriteByte** and **SMBusReadByte**. The inter-

face utility only accepts and outputs hexadecimal number format.

The **Hunt for active listeners** button scans the entire 2-wire address space, reporting each address that is acknowledged. The **SMBusWriteByte** transmits the device address, command, and one byte of data. The **SMBusReadByte** transmits the device address, a command, and then retransmits the device address and reads 1 byte of data. For information on the differences between a 2-wire and an SMBus interface, read application note "Comparing the I²C Bus to the SMBus" at www.maxim-ic.com

General Troubleshooting

Problem: software reports it cannot find the interface board.

- Is the interface board power LED lit?
- Is the USB communications cable connected?

MAX5954L Evaluation Kit/Evaluation System

- Has Windows plug-and-play detected the board? Bring up Control Panel->System->Device Manager, and look at what device nodes are indicated for USB. If there is an “unknown device” node attached to the USB, delete it—this forces plug-and-play to try again.
 - Are the SCL and SDA signals pulled up to VDD? The CMAXQUSB interface board dip switch SW1 enables the on-board resistors on the interface board. There must be pullup resistors somewhere for the SMBus SCL and SDA signals.
 - If using jumper wires to connect, are the SCL and SDA signals swapped? Is the ground return missing?
- Problem: Unable to find U2 (MAX7313)**
- Is power applied to the MAX5954L EV kit VIN2 and VIN3 banana jacks? This is required for powering U2.

Evaluate: MAX5954L/MAX5954A

MAX5954L Evaluation Kit/Evaluation System

Evaluate: MAX5954L/MAX5954A

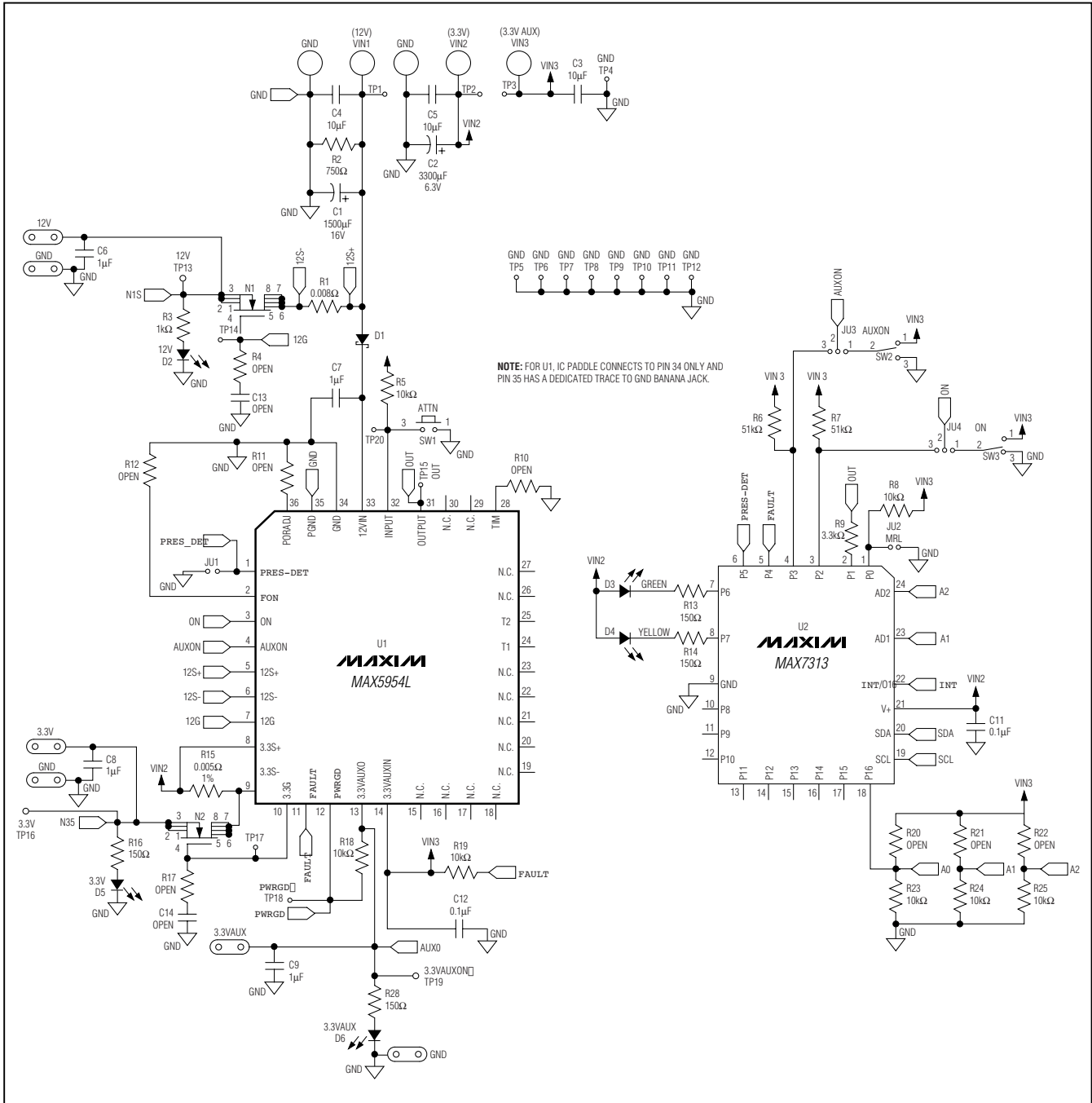

Figure 3. MAX5954L EV Kit Schematic

MAX5954L Evaluation Kit/Evaluation System

Evaluate: MAX5954L/MAX5954A

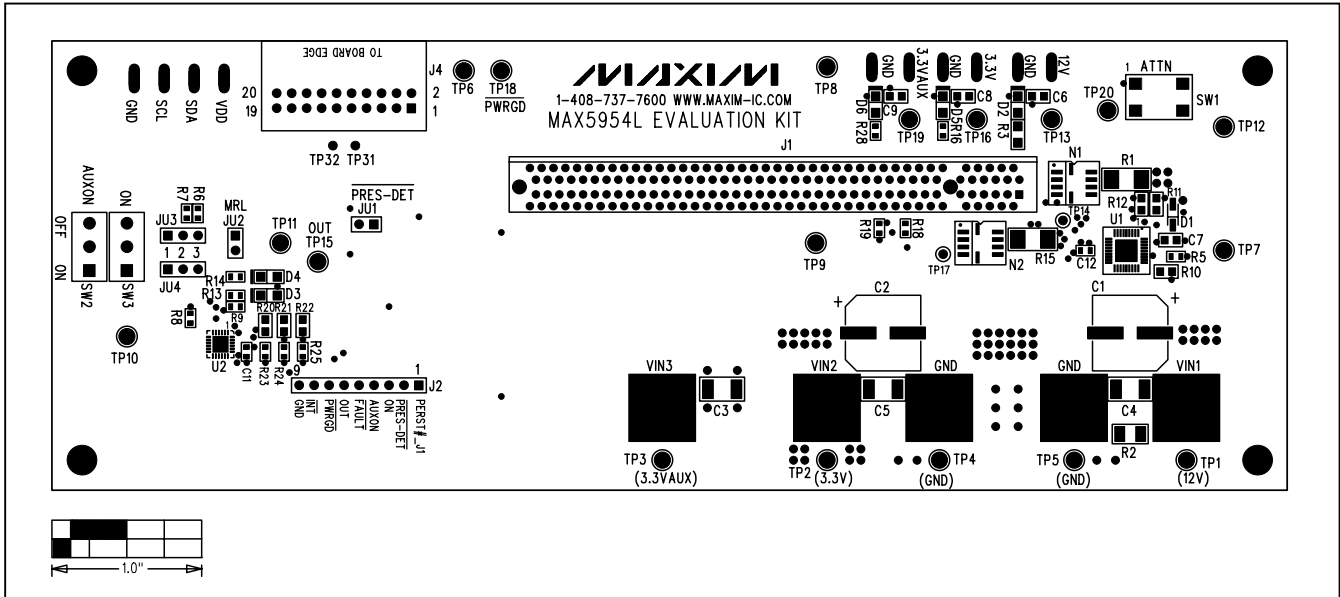

Figure 5. MAX5954L EV Kit Component Placement Guide—Component Side

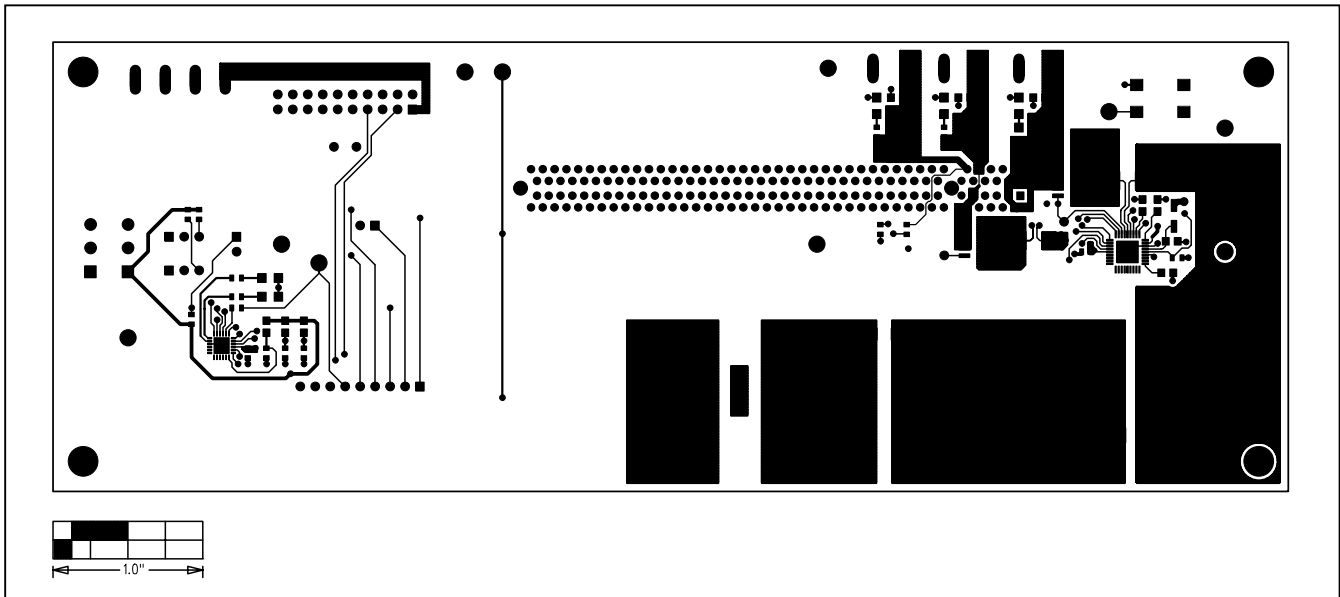

Figure 6. MAX5954L EV Kit PC Board Layout—Component Side

MAX5954L Evaluation Kit/Evaluation System

Evaluate: MAX5954L/MAX5954A

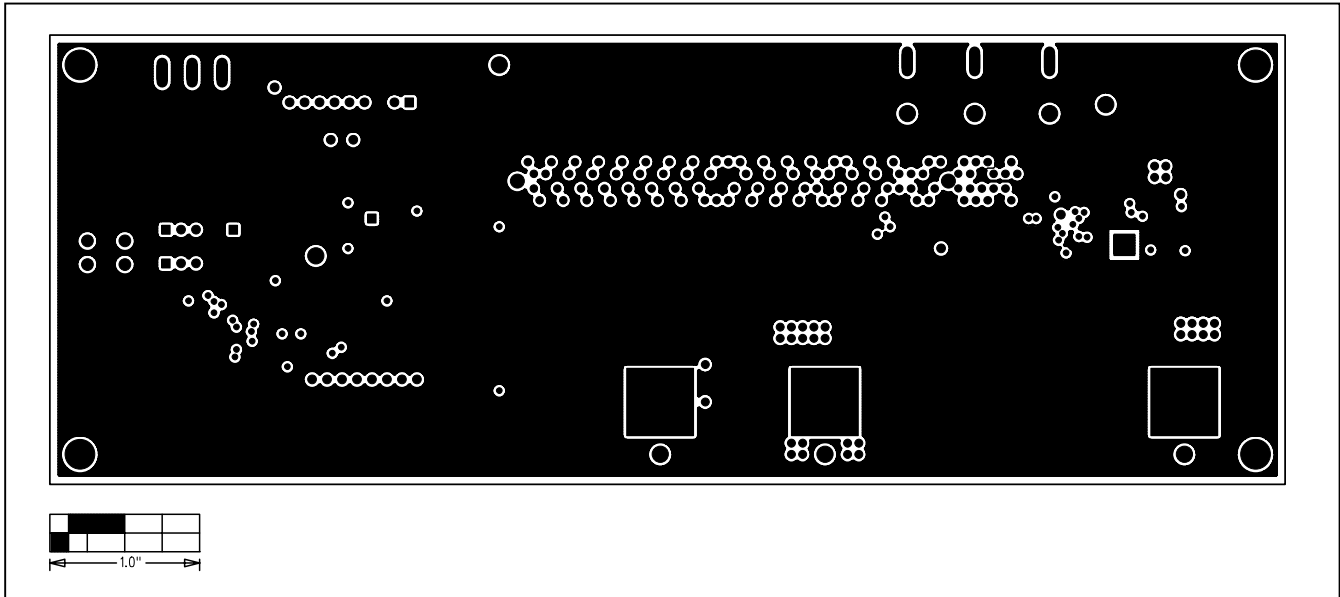

Figure 7. MAX5954L EV Kit PC Board Layout—Inner Layer, Ground Plane

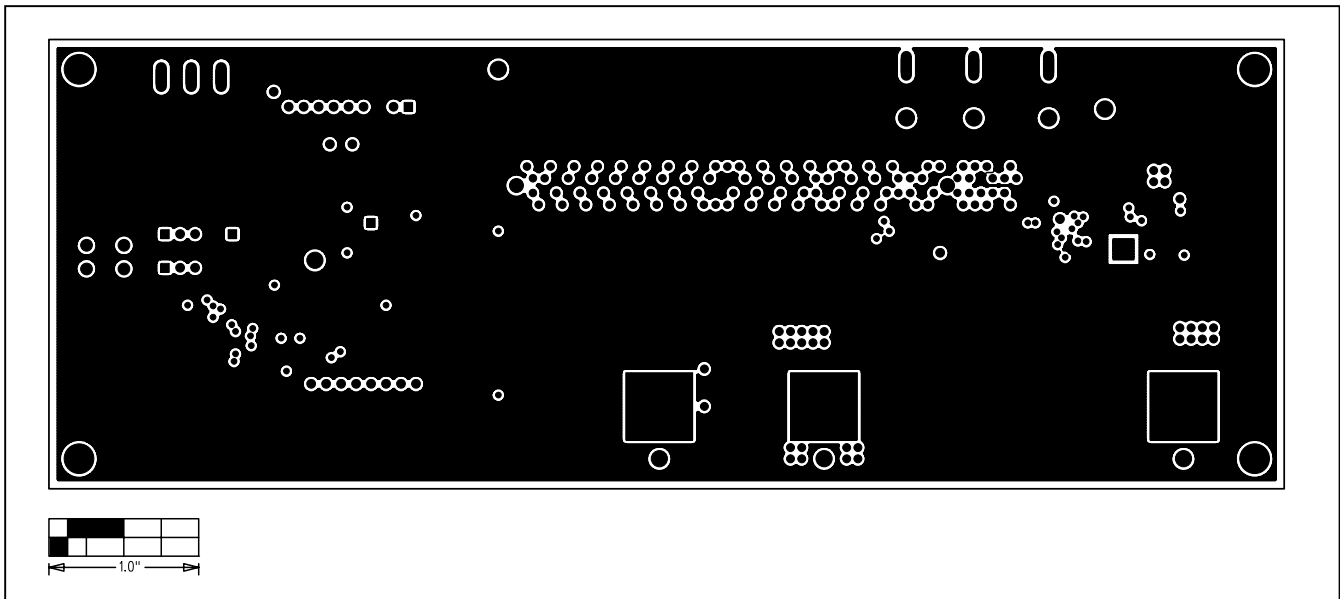

Figure 8. MAX5954L EV Kit PC Board Layout—Inner Layer, Power Plane

MAX5954L Evaluation Kit/Evaluation System

Evaluate: MAX5954L/MAX5954A

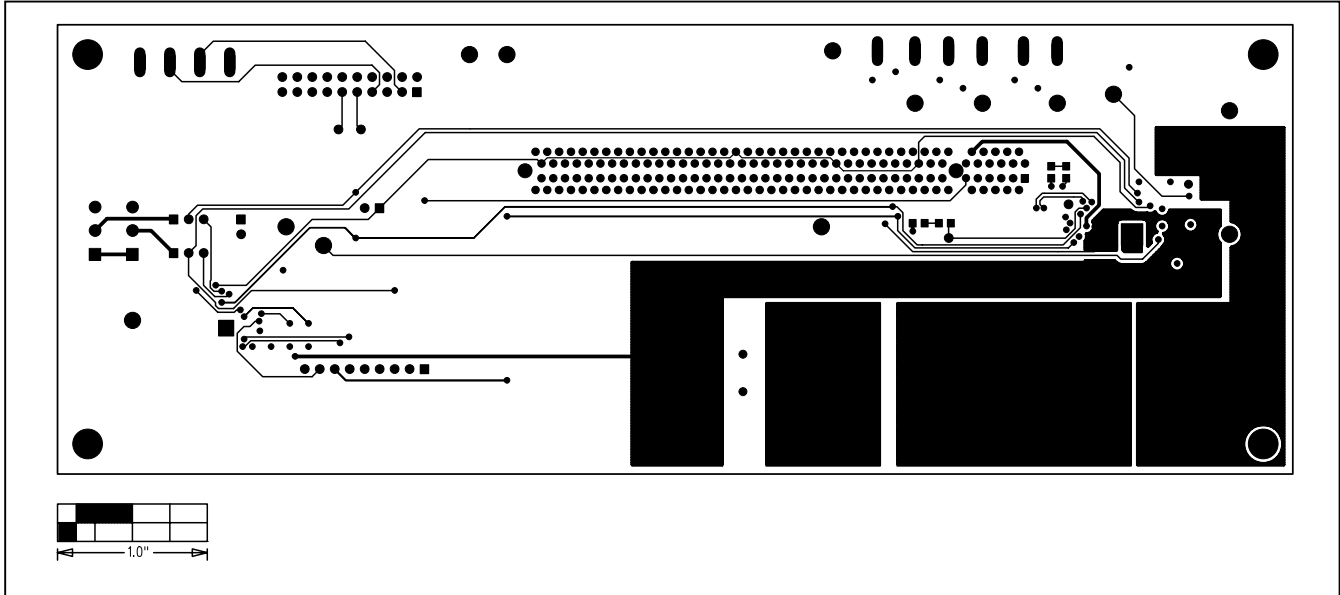

Figure 9. MAX5954L EV Kit PC Board Layout—Solder Side

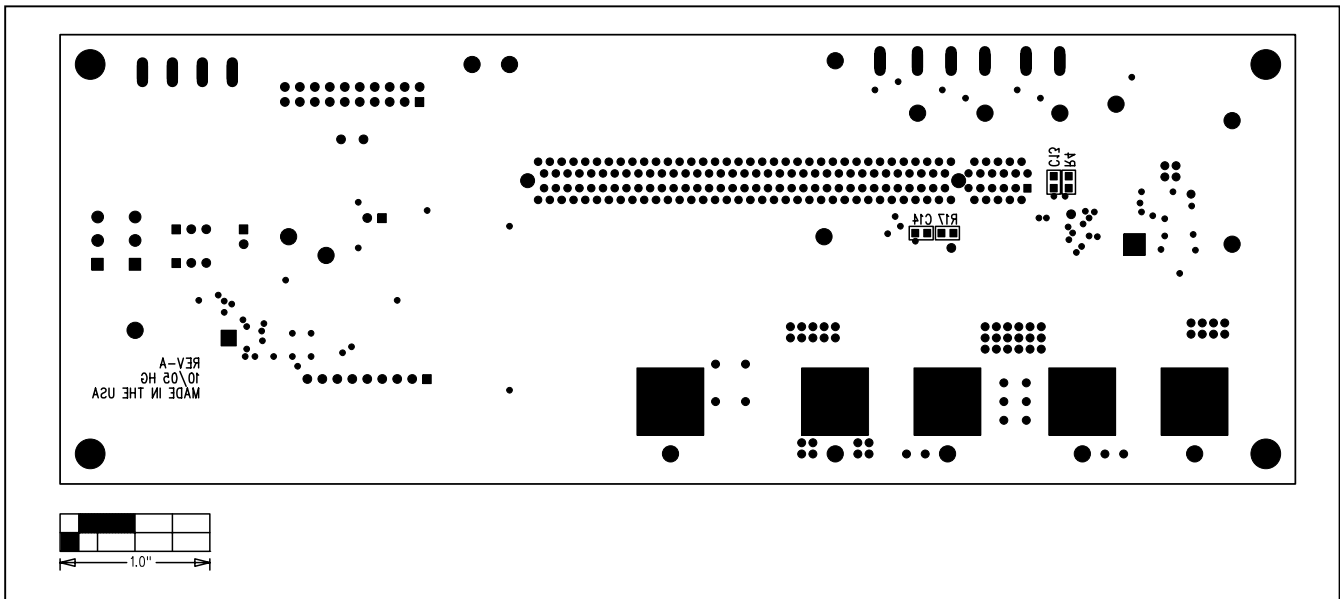

Figure 10. MAX5954L EV Kit Component Place Guide—Solder Side

Maxim cannot assume responsibility for use of any circuitry other than circuitry entirely embodied in a Maxim product. No circuit patent licenses are implied. Maxim reserves the right to change the circuitry and specifications without notice at any time.

14 _____ **Maxim Integrated Products, 120 San Gabriel Drive, Sunnyvale, CA 94086 408-737-7600**